

THREE SPINDLE IN-LINE ADJUSTABLE DRILLING HEAD, MODEL MS3L-13

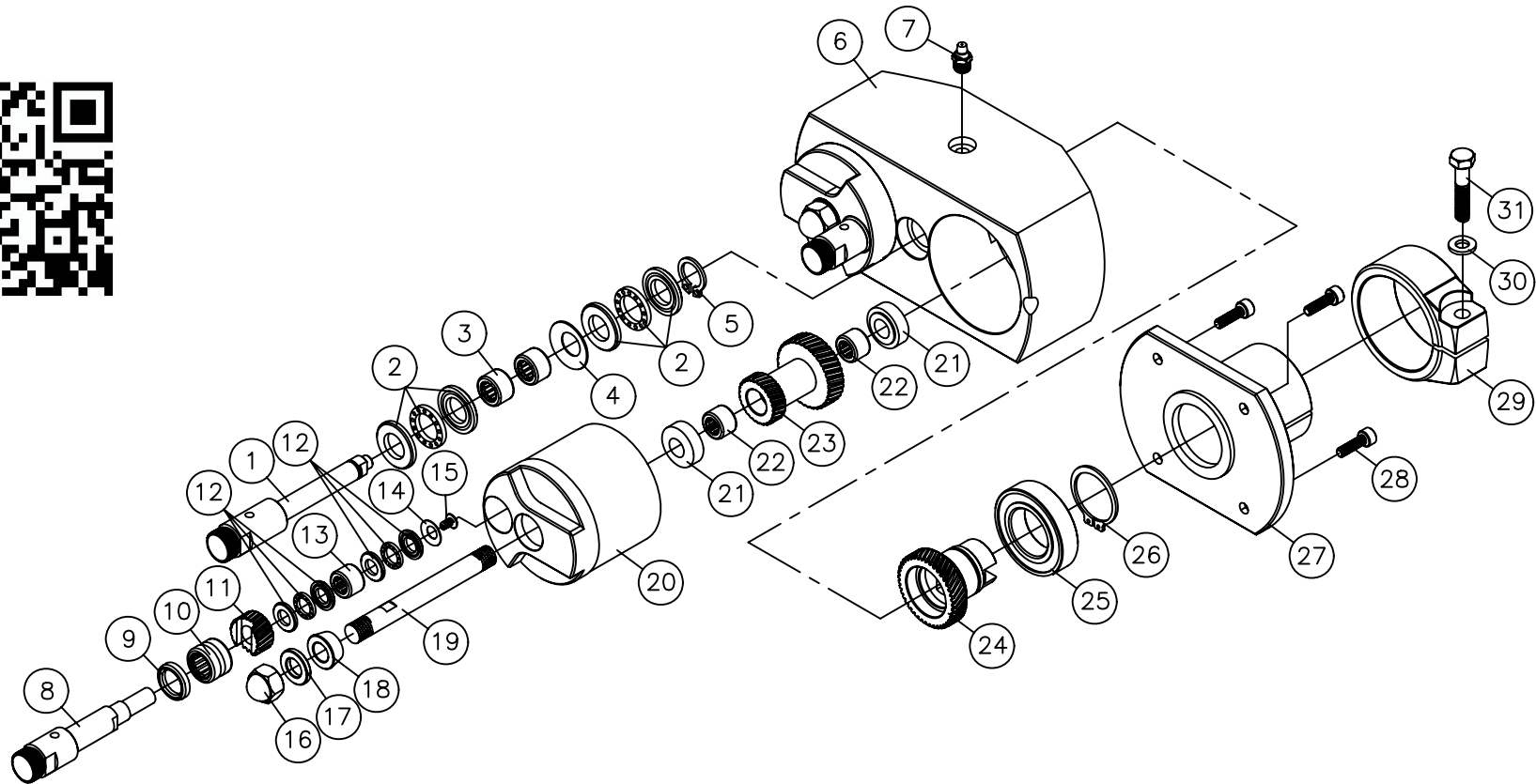

ITEM	QTY	DESCRIPTION	ITEM	QTY	DESCRIPTION	ITEM	QTY	DESCRIPTION
1	1	INTERMEDIATE SPINDLE	13	2	NEEDLE BEARING	25	1	BALL BEARING
2	2	THRUST BEARING	14	2	BELLEVILLE WASHER	26	1	SNAP RING
3	2	NEEDLE BEARING	15	2	SOCKET HEAD SCREW	27	1	ADAPTER
4	1	BELLEVILLE WASHER	16	2	NUT	28	4	SOCKET HEAD SCREW
5	1	SNAP RING	17	2	SPACER	29	1	ADAPTER CLAMP
6	1	HOUSING	18	2	CONICAL WASHER	30	1	ADAPTER CLAMP WASHER
7	1	GREASE FITTING	19	2	PRECISION STUD	31	1	ADAPTER CLAMP BOLT
8	2	SPINDLE	20	2	TURRET	32	3	COLLET
9	2	OIL SEAL	21	4	BRASS THICK WASHER	33	3	COLLET NUT
10	2	NEEDLE BEARING	22	4	NEEDLE BEARING			32 & 33 NOT SHOWN
11	2	GEAR	23	2	GEAR SET			
12	4	THRUST BEARING	24	1	DRIVE SPINDLE			